

GQ7 Series Single Phase Rail Mounting Energy Meter Manual



I. Features

- Multi active power accuracy can be chosen
- When load current $\leq 80A$, it is not necessary to connect current transformer (Only for 5 (80) A products).
- One loop active power pulse output (Meet the A type pulse output standard)
- One RS485 interface; The protocol for MODBUS-RTU or DL/T645-2007 is optional.
- LCD display, with white backlight. Display electrical parameters and Kwh in two lines.
- True effective value measurement ,electric parameters , kwh information can be displayed fixedly, autcycle or switched by panel key.
- Meet requirement of DL/T 614 , GB/T 17215 electric power meter technical standard.
- Optional multi tariff rate function , one day can be set into 12 periods , four kind pay rate.

II . Technical Specifications

Items	Specification
Accuracy Class	Active power:0.5S or 1.0S , reactive power 2.0S
Energy Display Range	Meter display 0.1 -999999.9Kwh , communication display 0.001-999999.999Kwh
Reference Voltage	220V AC /110V AC
Current	1.5 (6) A , 5(80) A
Measure Net	Single phase two wires
Work Voltage	normal work voltage : 0.9Un-1.1Un , Limit work voltage : 0.7Un-1.2Un
Start Current	0.001In(0.5S)
Power Consumption	Voltage circuit < 10VA , Current circuit< 1VA
Power Pulse Output	Active power pulse output . Photoelectric isolation , open-collector output .(Meet A type pulse output standard) Pulse width=80ms \pm 20ms
Digit Communication	RS485: Modbus RTU or DL/645-2007
Time Clock Error	≤ 0.5 second/day
Withstand Voltage	power and voltage circuit , ground , current circuit , communication , pulse output and power supply terminal , each two >2000VAC/1min
Anti-static Electricity	Contact Discharge >6KV , Air Discharge >8KV
Lighting Surge	Power supply $\pm 4000V$
Temperature Range	Normal work temperature:-10 ~ +45 $^{\circ}C$, limit work temperature: -20 ~ +55 $^{\circ}C$, Storage temperature :-40 ~ +70 $^{\circ}C$
Relative Humidity	$\leq 95\%$ (no condensation)
Size(mm)	76LX88WX60H(mm)

III. Function Explanation

Items	Function
Measure	With power direction auto-recognition and indication function (Reverse power accumulated into total power)
	Electric power is accumulated and stored in total , sharp , peak , shoulder , off-peak time consumption rate
	After the power failure,the data stored in the meter can be kept more than 10 years.
Clock and tariff	Clock has calendar , timing and leap year shift function , clock error is within 0.5s/day
	Programable sharp , peak , shoulder , off-peak rate setting , can set 12 periods/day , interval is 15minutes
Display	Wide-temperature range LCD display , upper line display electric parameter , lower line display various kinds of energy value , time
	3 LED indicate communication status ,active power pulse output , power reverse separately
Communication	used in meter setting , remote meter reading , data collection ect
	Communication interface: RS485
	Communication protecol: Modbus RTU (others can be ordered)
	Baud Rate : 4800bps , 9600bps
Meter programming	Time , data setting
	Communication address setting
	Tariff rate period setting
	zero clearance setting of Kwh
	Meter programming setting can be finished by PC software

IV. Model Illustration

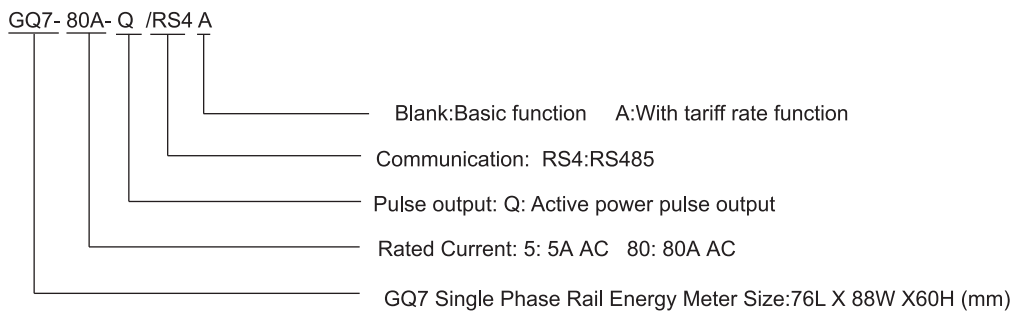

V. Model

Model	Accuracy	Rated Voltage	Current	Input Type	Multi Tariff Rate	Communication	Pulse Constant
GQ7-5A-Q/RS4	0.5S	220V 110V	5A	via CT	No	Modbus-RTU or DL/T645-2007	12000 imp/kwh
GQ7-5A-Q/RS4A					Yes		
GQ7-80A-Q/RS4	1.0S		80A	direct input	No		2400 imp/kwh
GQ7-80A-Q/RS4A					Yes		

VI. Panel Illustration

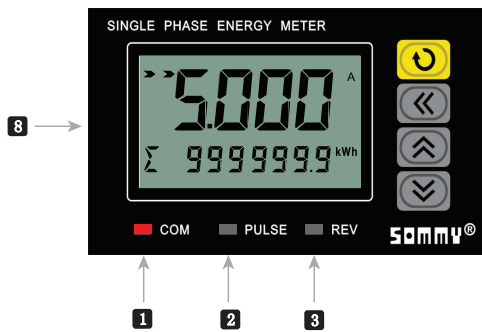

No.	Mark	Name	Illustration
1	COM	Communication light	The light will be shining when has communication
2	PULSE	Pulse output indication	The light will be shining when pulse output
3	REV	Status indication light	Power reverse indication
4	↕	Increase key	The first line display switch key / Increase key
5	↖	Decrease key	The first line display switch key / decrease key
6	⏪	Shift key	The second line display switch key/modify/shift/return
7	⏹	Menu key	The second line display switch key/menu/confirm/exit
8		LCD Display Screen	Upper line display parameters , lower line display Kwh

VII . Connection Drawing

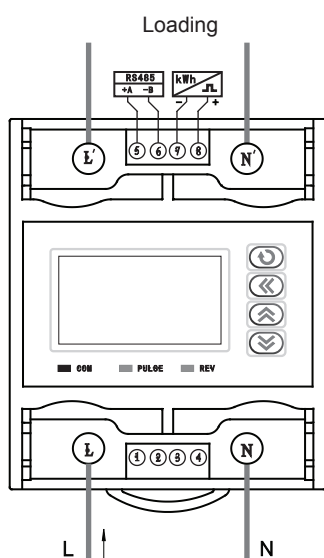

Single phase two wires direct input
(suitable for maximum direct current 80A type)

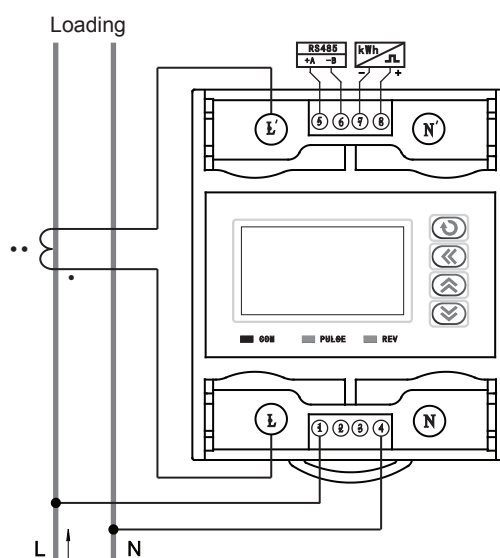

Single phase two wires input via CT
(suitable for maximum direct current 5A type)

VIII. Operation Illustration

- Under the measuring status, press **◀** and **⏻** respectively, to switch display the total active power Kwh, total reactive power, total sharp Kwh, total peak Kwh, total off-peak time Kwh, total Kwh this month, total sharp Kwh this month, total peak Kwh this month, total shoulder Kwh this month, total off-peak time Kwh this month, total Kwh last month, total sharp Kwh last month, total peak kwh last month, total shoulder Kwh last month, total off-peak time Kwh last month, total Kwh the month before last month, total sharp kwh the month before last month, total peak Kwh the month before last month, total shoulder kwh the month before last month, total off-peak kwh the month before last month, present time, date. With power failure memory function.
- Under the measuring status, press **⏻** and **⏮** to switch display the voltage, current, active power, reactive power, power factor, frequency. With power failure memory function.
- Enter the menu. Press **⏻** for several seconds to enter into setting menu. Press **⏮** to show the menus in circyle forward, Press **⏭** to show the menus in circyle backward.
- Modify parameter setting in the menu. After entering into the menu, press **⏻** or **⏮** to find the meui to be modified. Press **◀**, second line parameters will be flashing. Then press **◀** to flash each digit in circyle. Press **⏮** to increase the value, press **⏭** to decrease the menu. After finishing modification, press **⏻** to confirm the modification.
- Enter into tariff rate menu. In measure status, press **◀** for several seconds to enter into tariff rate setting menu, short press **◀** to flash the parameter to modify, press **⏮** or **⏭** to shift the menu, press **⏻** to confirm and save the data. Long press **⏻** to exit the menu.
- Exit the menu. In menu status, press **⏻** several seconds to exit to normal measure status. If do not operate the menu more than 40 seconds, meter will exit the menu to normal measure status.

IX. Menu Operation

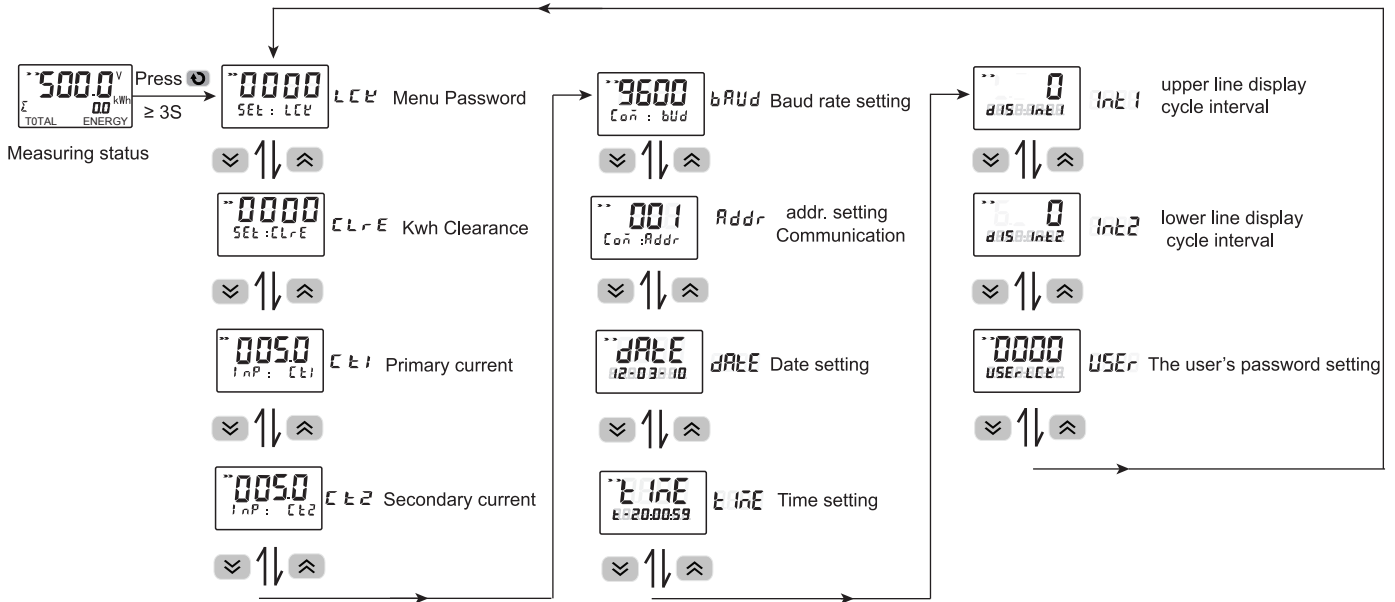

X. Menu Setup

No.	Code	Parameter	Range	Illustration	Default value
1	LCK	User's Password	0-9999	When LCK is equal to the user's password, can change the data, otherwise all of the menus only can be read	0000
2	CLRE	clear energy	0-9999	Must input the correct password to clear Kwh	0000
3	CT1	CT primary current	0.1-999.9	Primary current of current transformer	5.0
4	CT2	CT Secondary current	0.1-9.9	Secondary current of current transformer	5.0
5	bUd	Communication baud rate setting	4900/9600	4800 or 9600 baud	9600
6	Addr	Communication addr. setting	1-247	Meter address range	1
7	dAtE	Date setting	12-03-10	Set present date of the meter, format is 20xxyear-xxmonth-xxdate	Present date
8	tInE	Time setting	20:00:59	Set present time of the meter, format is xx hour xx minute xx second	Present time
9	int1	upper line display cycle interval	0-9	0 floating display, 4-9 display time interval circularly (Unit: second)	0
10	int2	lower line display cycle interval	0-9	0 floating display, 4-9 display time interval circularly (Unit: second)	0
11	USER	User's menu password setting	0-9999	Don't change the user's password at random	0000

XI. Multi-tariff Rate Menu Operation

Operating: Under the measuring status, long press **←** to enter into tariff rate setting, after finishing setting press **↻** to exit.

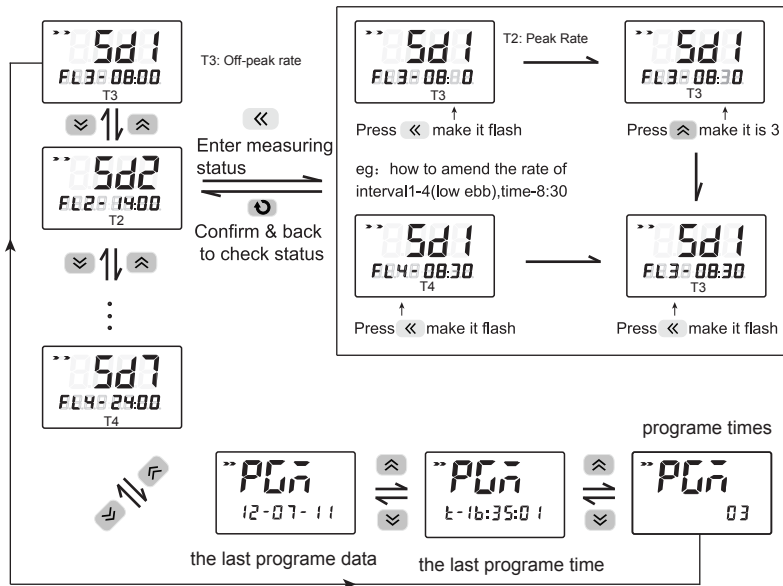

Illustrations:

- The meter can set 12 periods at most, corresponding to 4 tariff rates: sharp, peak, flat, vale
- Tarrif rate: T1: sharp rate, T2: peak rate, T3: Flat rate, T4: Vale rate
- The minimum period is 15 minutes
- Start from period 1, the setting time of present period must be \geq set time of previous tariff rate period.
- In actual usage, if not use all the 12 periods, just need to set the unused periods time is the same with the last effective period time.
Eg: If use 6 periods, the last effective period SD6=24:00, set the unused period SD7=SD6=24:00 (The menu after SD7 period will be shield automatically).
- PGM display the last programming date, time and total programmed times.

Eg2: The present setting is 1 period, tariff rate is off-peak.

The start time of present tariff rate period is 8:00am (As shown in the blow)

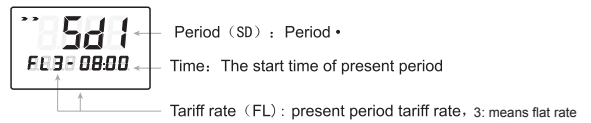

Eg1: For example, the user's energy measurement is divided into 6 periods, 1 period is flat tariff rate, starts from 8:00; 2 period is peak rate starts from 14:00; 3 period is flat rate starts from 17:00; 4 period is peak rate, starts from 19:00; 5 period is flat tariff rate starts from 22:00; 6 period is vale rate, starts from 24:00. (Meter setting is as blow)

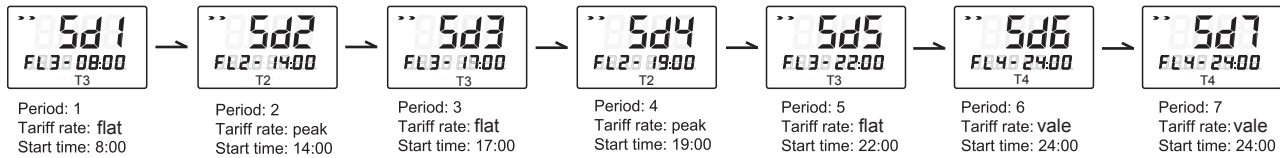

Note: FL1 means sharp rate, FL2 means peak rate, FL3 means flat rate, FL4 means vale rate

XII. Parameter Illustration

Σ TOTAL	Total accumulated Kwh since meter is power on	Σ T1	Accumulated sharp kwh since meter is power on
Σ T2	Total peak kwh since meter is power on	Σ T3	Total flat kwh since meter is power on
Σ T4	Total vale kwh since meter is power on	TOTAL	Accumulated Kwh this month
T1	Accumulated sharp Kwh this month	T2	Accumulated peak kwh this month
T3	Accumulated flat kwh this month	T4	Accumulated vale kwh this month
LAST MONTH TOTAL	Accumulated Kwh last month	LAST MONTH TOTAL T1	Accumulated sharp Kwh last month
LAST MONTH TOTAL T2	Accumulated peak Kwh last month	LAST MONTH TOTAL T3	Accumulated flat kwh last month
LAST MONTH TOTAL T4	Accumulated vale kwh last month	LAST II MONTH TOTAL	Accumulated Kwh the month before last month
LAST II MONTH TOTAL T1	Accumulated sharp kwh the month before last month	LAST II MONTH TOTAL T2	Accumulated peak Kwh the month before last month
LAST II MONTH TOTAL T3	Accumulated flat kwh the month before last month	LAST II MONTH TOTAL T4	Accumulated vale kwh the month before last month

Dimension (Unit: mm)

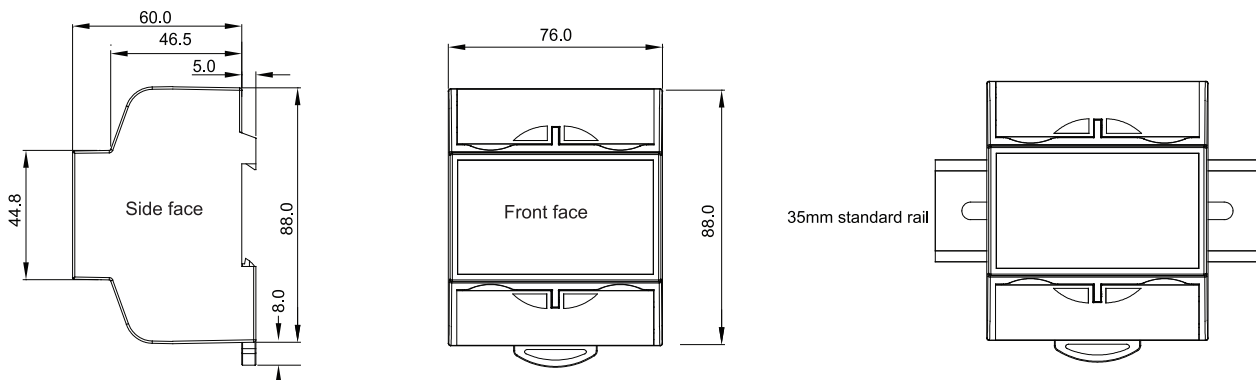

X IV. Communication protocol

GQ7 series electric energy meter adopts Modbus communication protocol, to process RS485 half-duplex communication; Reading function code: 0x03, writing function code: 0x10; Adopt 16 digit CRC check. The meter does not feedback the check error.

Data frame format:

Start bit	Data bit	Stop bit	Check bit
1	8	1	No

The abnormal communication handing:

When the response is abnormal, the high bit of function code will be set as 1. For example, if the request function code from master is 0x04, the function code back from the slave is 0x84.

The type of error code:

0x01--- Function code error: the meter does not support function code received.

0x02--- Data position error: the data position assigned by the mater is out of the range of meter.

0x03--- Data values error: the data value sent from master is out of the range of meter

1. Read multi – register

eg. Master reads floating data U (Voltage is 220.0 V)

The address code of Ua is 0x4000, because U is double byte (4 Bytes), and seizes 2 data registers.

The decimal system 220.0V is correspond to 0X00035B60.

Master request (Read multi – register)							
1	2	3	4	5	6	7	8
Meter addr.	Function code	Start addr. High bit	Start addr. Low bit	Data byte length high bit	Data byte length low bit	CRC code low bit	CRC code high bit
0x01	0x03	0x40	0x00	0x00	0x02	0xD1	0xCB

slave normal answer(Read multi-register)								
1	2	3	4	5	6	7	8	9
Meter addr.	Function Code	Data Bytes	Data low high byte	Data low low byte	Data high high byte	Data high low byte	CRC code low bit	CRC code high bit
0x01	0x03	0x04	0x5B	0x60	0x00	0x03	0xA9	0X08

The answer of abnormal function code:(eg: The request function code from mater is 0x04)

Slave abnormal answer (Read multi-register)				
1	2	3	8	9
Meter Addr.	Function Code	Error Code	CRC Code Low Bit	CRC Code High Bit
0x01	0x84	0x01	0x82	0xC0

2. Write multi-register

eg: Master write CT1=100.0A

CT1 address code is 0x4804 , data format is double byte(4 bytes), seizes 2 data registers , decimal system 100.0A is correspond to 0x000186A0

Master request (write multi – register)												
1	2	3	4	5	6	7	8	9	10	11	12	13
Meter addr.	Function code	Start addr. High bit	Start addr. low bit	Data byte length high bit	Data byte length low bit	Date byte length	Date 1 high bit	Date 1 low bit	Date 2 high bit	Date 2 low bit	Low bit of CRC code	High bit of CRC code
0x01	0x10	0x48	0x04	0x00	0x02	0x04	0x86	0xA0	0x00	0x01	0x4C	0xF5

Slave normal answer (write multi-register)							
1	2	3	4	5	6	7	8
Meter addr.	Function code	Start addr. high 8 bit	Start addr. low 8 bit	Data byte length high bit	Data byte length low bit	CRC code low bit	CRC code high bit
0x01	0X10	0x48	0x04	0x00	0x02	0x17	0xA9

Date position Error response: (eg.: The write address index for master request is 0x0050)

Slave abnormal answer (write multi-register)				
1	2	3	4	5
Meter addr.	Function code	Error code	Low bit of CRC code	High bit of CRC code
0x01	0x90	0x02	0xCD	0XC1

No.	Register address	Register Name	Byte length	Value range	Variable attributes	Remarks
1	0x0080	The current date-year	1	int	R	1.The return data is BCD format 2. The year data starts from 2000 3. Eg: Read year return datasheet 0X0012 ,means present year is 2012 . 4. Eg.: Read minute return 0X0056, it means present minute is 56 minutes.
2	0x0081	The current date-month	1	int	R	
3	0x0082	The current date-day	1	int	R	
4	0x0083	The current time-hour	1	int	R	
5	0x0084	The current time-minute	1	int	R	
6	0x0085	The current time-second	1	int	R	
7	0x4000	Voltage	2	long	R	0x01 = 0.001V
8	0x400C	Current	2	long	R	0x01 = 0.001A
9	0x4012	Active power	2	long	R	0x01 = 0.001kW
10	0x401A	Reactive power	2	long	R	0x01 = 0.001kvar
11	0x4022	Apparent power	2	long	R	0x01 = 0.001kVA
12	0x402A	The power factor	2	long	R	0xC8 = 0.2PF
13	0x4032	The frequency	2	long	R	0xC350 = 50HZ
14	0x4034	Total active energy Kwh	2	long	R	0x01 = 0.001kWh
15	0x4036	Total reactive energy KvarH	2	long	R	0x01 = 0.001kvarh
16	0x4102	Total sharp Kwh	2	long	R	0x01 = 0.001kWh
17	0x4104	Total peak Kwh	2	long	R	
18	0x4106	Total off-peak Kwh	2	long	R	
19	0x4108	Total shoulder Kwh	2	long	R	
20	0x410A	Total Kwh this month	2	long	R	
21	0x410C	Total sharp Kwh this month	2	long	R	
22	0x410E	Total peak Kwh this month	2	long	R	
23	0x4110	Total off-peak Kwh this month	2	long	R	
24	0x4112	Total shoulder Kwh this month	2	long	R	
25	0x4114	Total Kwh last month	2	long	R	
26	0x4116	Total sharp Kwh last month	2	long	R	
27	0x4118	Total peak Kwh last month	2	long	R	
28	0x411A	Total off-peak Kwh last month	2	long	R	
29	0x411C	Total shoulder Kwh last month	2	long	R	
30	0x411E	Total Kwh the month before last month	2	long	R	
31	0x4120	Total sharp Kwh the month before last month	2	long	R	
32	0x4122	Total peak Kwh the month before last month	2	long	R	
33	0x4124	Total off-peak Kwh the month before last month	2	long	R	
34	0x4126	Total shoulder Kwh the month before last month	2	long	R	
35	0x4200	Total programming times of tariff rate	2	long	R	
36	0x4202	The 1st time tariff rate programming date recently	2	long	R	0x00YYMMDD(BCD)
37	0x4204	The 1st time tariff rate programming time recently	2	long	R	0x00HHMMSS(BCD)
38	0x4206	Total Kwh value of 1st time kwh clearance recently	2	long	R	0x01=0.001kWh
39	0x4208	The date of 1st time to clear Kwh recently	2	long	R	0x00YYMMDD(BCD)
40	0x420A	Total Kwh value of 2nd time kwh clearance recently	2	long	R	0x01=0.001kWh
41	0x420C	The date of 2nd time to clear Kwh recently	2	long	R	0x00YYMMDD(BCD)
42	0x420E	Total Kwh value of 3rd time kwh clearance recently	2	long	R	0x01=0.001kWh
43	0x4210	The date of 3rd time to clear Kwh recently	2	long	R	0x00YYMMDD(BCD)
44	0x4212	Total Kwh value of 4th time kwh clearance recently	2	long	R	0x01=0.001kWh
45	0x4214	The date of 4th time to clear Kwh recently	2	long	R	0x00YYMMDD(BCD)
46	0x4216	Total Kwh value of 5th time kwh clearance recently	2	long	R	0x01=0.001kWh
47	0x4218	The date of 5th time to clear Kwh recently	2	long	R	0x00YYMMDD(BCD)
48	0x4804	CT primary current	2	long	R/W	0x1388 = 5.000A

Reserve expanding						
49	0x4806	CT secondary current	2	long	R/W	0x1388 = 5.000A
50	0x4A01	Communication address	1	int	R/W	1~247
51	0x4A02	Communication baud rate	1	int	R/W	0=9600、1=4800(kbS)
52	0x4A07	Upper line display cycle time interval	1	int	R/W	0 = fixed display 4~9 = Display time interval (second)
53	0x4A08	Lower line display cycle time interval	1	int	R/W	
54	0x4A80	Period 1 tariff rate	1	int	R/W	0 = Sharp tariff rate 1 = Peak tariff rate 2 = off-peak tariff rate 3 = shoulder tariff rate
55	0x4A81	Period 2 tariff rate	1	int	R/W	
56	0x4A82	Period 3 tariff rate	1	int	R/W	
57	0x4A83	Period 4 tariff rate	1	int	R/W	
58	0x4A84	Period 5 tariff rate	1	int	R/W	
59	0x4A85	Period 6 tariff rate	1	int	R/W	
60	0x4A86	Period 7 tariff rate	1	int	R/W	
61	0x4A87	Period 8 tariff rate	1	int	R/W	
62	0x4A88	Period 9 tariff rate	1	int	R/W	
63	0x4A89	Period 10 tariff rate	1	int	R/W	
64	0x4A8A	Period 11 tariff rate	1	int	R/W	
65	0x4A8B	Period 12 tariff rate	1	int	R/W	
66	0x4A8C	Period 1 start time	1	int	R/W	0~96
67	0x4A8D	Period 2 start time	1	int	R/W	
68	0x4A8E	Period 3 start time	1	int	R/W	
69	0x4A8F	Period 4 start time	1	int	R/W	
70	0x4A90	Period 5 start time	1	int	R/W	
71	0x4A91	Period 6 start time	1	int	R/W	
72	0x4A92	Period 7 start time	1	int	R/W	
73	0x4A93	Period 8 start time	1	int	R/W	
74	0x4A94	Period 9 start time	1	int	R/W	
75	0x4A95	Period 10 start time	1	int	R/W	
76	0x4A96	Period 11 start time	1	int	R/W	
77	0x4A97	Period 12 start time	1	int	R/W	
78	0x4A98	Present tariff rate	1	int	R	0-3
79	0x4A99	The overflow times of total Kwh	1	int	R	0-255
Reserve tariff rate expanding						

The program of achieving 16 bit CRC check code

```

unsigned int Get_CRC (uchar*pBuf,uchar num)
{
    unsigned i,j;
    unsigned int wCrc=0xFFFF;
    for(i=0;i<num;i++)
    {
        wCrc^=(unsigned int)(pBuf[i]);
        for(j=0;j<8;j++)
        {
            if(wCrc &1) { wCrc>>=1; wCrc=0xA001; }
            else wCrc>>=1;
        }
    }
    return wCrc;
}

```